



## FIMI X8 Pro User Manual

Please read the user manual carefully before using and keep the manual for future reference.



# Contents

Services & Support	.....	·1
Package List	.....	·2
Product Instruction	.....	·3
Drone	.....	·6
Safety and Protection	.....	·7
Intelligent flight	.....	·9
Visual System and Infrared Sensing System	.....	·16
Assembly and Disassembly	.....	·19
Smart battery	.....	·21
Gimbal and Camera	.....	·24
Remote controller	.....	·26
APP	.....	·31
Fly	.....	·34
Maintenance and Calibration	.....	·37
Basic Specification	.....	·41

# Services & Support

FIMI provides X8 Pro users with tutorial videos and the following information:

1. FIMI X8 Pro User Manual
2. FIMI X8 Pro Quick Start Manual
3. FIMI X8 Pro Disclaimer and Safety Operation Instructions

Users are advised to watch tutorial videos before using the product and read FIMI X8 Pro Disclaimer and Safety Operation Instructions carefully and get to know the process of using by going through FIMI X8 Pro Quick Start Manual. For more detailed product information, please refer to FIMI X8 Pro User Manual.

Please download the firmware and watch the tutorial videos on the link <https://www.fimi.com/download-fimi-x8-pro.html>

4. Please scan the the following QR-code to download Fimi Navi 3.0 App



## Product Instruction

The FIMI X8 Pro is an aerodynamic foldable drone equipped with intelligent control, wireless communication and other advanced technology which are necessary to realize functions like long-distance remote control, intelligent flight, precise landing, etc. The built-in 3-axis gimbal stabilizes the camera which is able to shoot 4K video at 30 fps and which performs HD real-time image transmission. The APP enriches the remote controller with more features and fast connection. The remote controller fits iPad Mini at the maximum range. The sticks are detachable.

## Reading tips (Symbol description)



Operation prohibited



Important notes



Operation, Usage tips



Glossary, Reference Information

## Package List

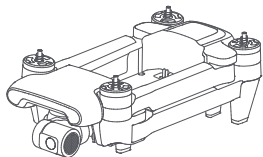

Drone x 1

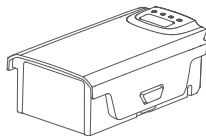

Battery x 1

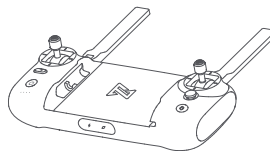

Remote controller x 1

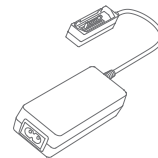

Charger x 1

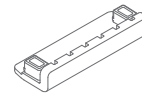

Dustproof plug x 1

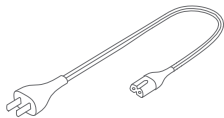

AC cable x 1



Positive propeller x 3  
Reverse propeller x 3



Gimbal protector x 1

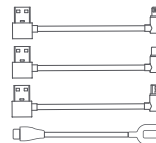

USB cable x 3



Instruction x 2

# Product Introduction

## 1 Drone

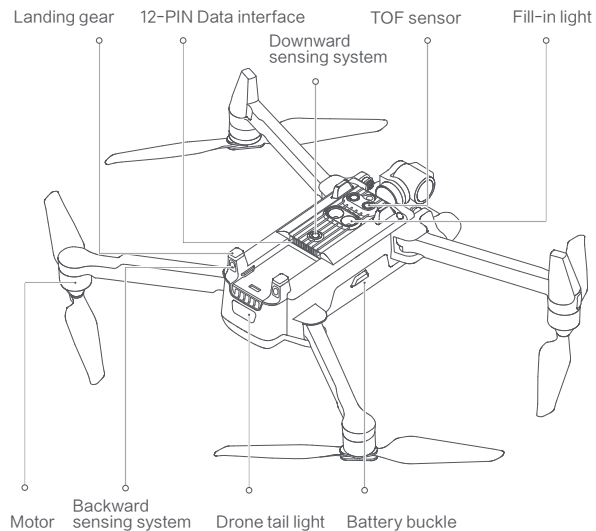
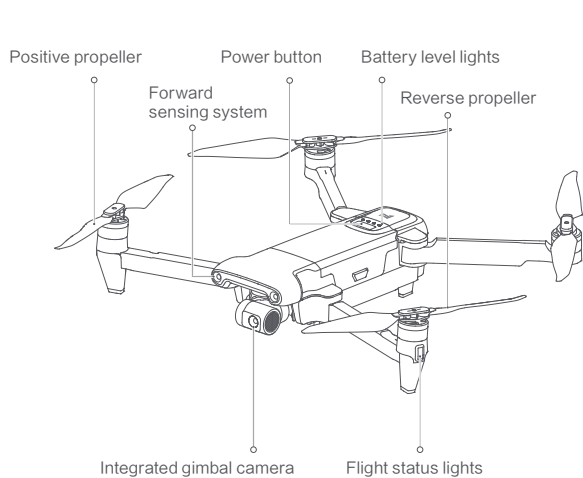

## 2 Remote controller

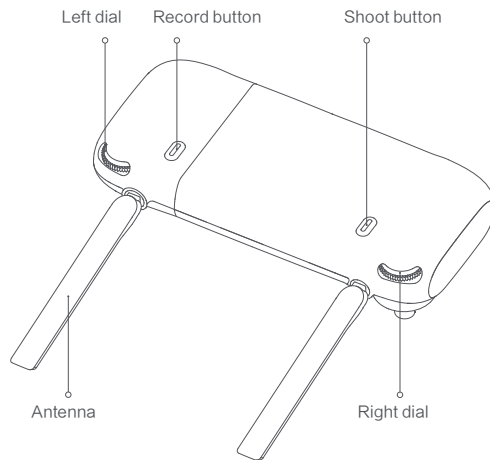
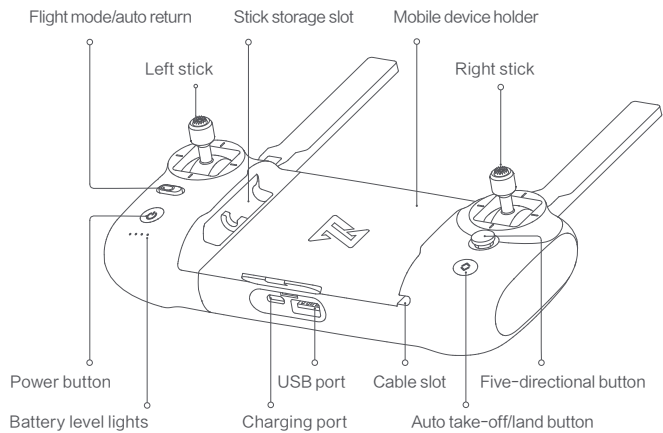

## Function Introduction of RC

	Buttons	Function description	
1	Left stick	Push stick upward, the drone goes up; pull stick downward, the drone goes down; toggle stick to left, the drone rotates counter-clockwise; toggle stick to right, the drone rotates clockwise	
2	Right stick	Push stick upward, the drone flies forward; pull stick downward, the drone flies backward; toggle stick to left, the drone flies to left; toggle stick to right, the drone flies to right	
3	Auto return	Toggle the button to the left, switching to normal flight Toggle the button to the right, switching to auto return	
4	Auto take-off/land button	long press 2 seconds to auto take off/landing	
5	Shoot button	short press to start / stop shooting	
6	Record button	Short press to start /stop recording	
7	Five directional button	Up	Default to switch between map / FPV
		Down	Default to switch between gimbal center/down
		Left	Default to turn on / off battery info interface
		Right	Default to turn on / off self-checking interface
		Center	Default to turn on/off media library
8	Left dial	Adjust the pitch angle of gimbal	
9	Right dial	Adjust the value of EV / ISO	
10	Power button	Short press to view the battery level	
		Short press+long press 2 seconds to power on / off	

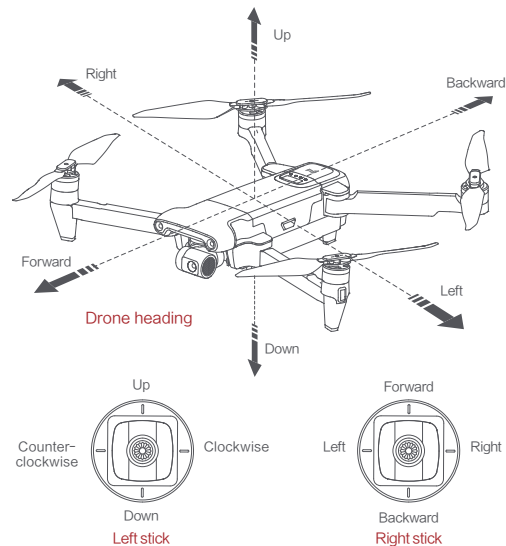

- ⚠ • The other functions of the five-directional button can be set in the FIMI Navi 3.0 App.
- The joystick function is the default mode, which can be set through the FIMI Navi 3.0 App.

- ⚠ • The stick mode can be set in FIMI Navi app (the default is American hand).



# Drone

## Flight Mode

### GPS Mode

To achieve precise hovering, the drone is equipped with a GPS module. The intelligent flight function works in GPS mode. Users can enable Sport Mode or Beginner Mode in the flight settings. When the Beginner Mode is on, the flight speed, flight distance, flight altitude and RTH altitude will be limited. In sport mode, the maximum flight speed is 18m/s(65 km/h), the maximum ascending speed is 5m/s(18 km/h), and the maximum descending speed is 4m/s(14 km/h).

### VPU Mode

An Optical Flow module is also built into the drone for precise hovering and landing at the home point. In VPU mode, the Intelligent flight function is not supported. The maximum flight speed is 10m/s(36 km/h), the maximum ascend speed is 3m/s(11 km/h), and the maximum descending speed is 2m/s (7 km/h). When the drone is flying above a well-lit ground with a clear texture and the GPS signal is poor, it will switch automatically to VPU mode.

### ATTI Mode

When the GPS signal is poor or the compass has interference, the drone enters in ATTI mode. In this mode, the drone can start drifting horizontally and intelligent flight mode is not supported. Therefore, in case of any accidents, we recommend flying in an open area with good GPS signal reception. Once the drone enters in ATTI mode, please land in a safe place as soon as possible.

- ⚠ At altitudes above 2400 meters, the sport mode will be deactivated.
- When flying in sport mode, the visual system will not function, and the drone will be unable to brake or avoid obstacles actively.
- When flying in sport mode, the drone's speed will be significantly increased compared to normal mode, resulting in a corresponding increase in braking distance.
- When flying in windless environment, users should reserve a minimum braking distance of at least 40 meters to ensure flight safety. During ascent or descent, users should reserve a minimum braking distance of at least 10 meters to ensure flight safety.

## Drone Lights

	Drone lights	Drone status
1	All lights are fading in and out	Self-checking
2	All lights are on	Drone on the ground: self-check fails
		Drone is flying: internal error
3	The yellow lights are on and the red and green light is flashing at regular intervals	Ready to fly / in flight
4	All lights flashing twice	Low battery alerts
5	All lights are flashing quickly	Very low battery alert: land as soon as possible
6	The red and green flashing quickly	The firmware of the drone is updating
7	Fill-in light	Automatically/manually opened

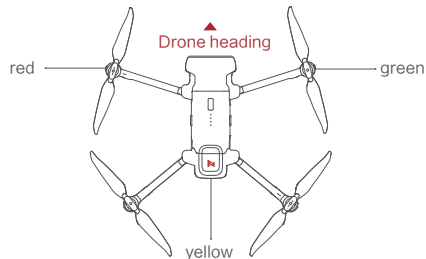

# Safety Protection

## Failsafe Return

Fimi Navi 3.0 allows setting the behavior of the drone when the remote control signal is interrupted to return, land, or hover. When set to return, if the GNSS signal is strong, the compass is functioning properly, and the return point is successfully recorded, the drone will be deemed disconnected if the signal between the drone and the remote control is interrupted for 2 seconds or more. The drone will then initiate a return flight in the event of disconnection. The flight control system will take over control of the drone and reference the original flight path to plan the return route, guiding the drone back to its takeoff point. If the connection between the drone and the remote control is restored during the return flight, the option to cancel the disconnected return will be available, and control of the drone will be handed back.

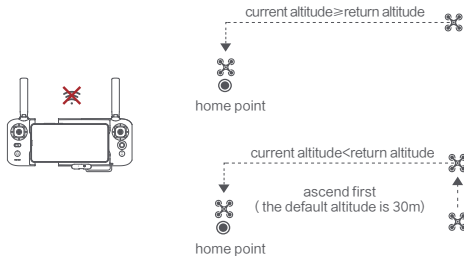

## Hovering on the Edge of No-fly-zone

The drone will automatically hover in the restricted flight area designated by the state, such as the edge of airports, and the App will appear corresponding hints. The user can use sticks to fly the drone from the edge of the no-fly-zone, but the drone will not enter the no-fly-zone.



## Low-power Protection

In flight, when the battery level is only enough for RTH, App advises users to return, and the drone will return automatically after 10 seconds countdown. When the battery level is only enough for landing, App advises users to land as soon as possible, and the drone will land automatically after 10 seconds countdown. When the battery level is at 15% usage left, the drone will be forced to land.

## Intelligent Low Battery Return

When the intelligent flight battery of the drone is critically low and there is not enough power for a return, the user should promptly land the drone. Otherwise, if the battery is completely depleted, the drone will descend rapidly, leading to potential damage or other hazards. To prevent unnecessary risks due to insufficient battery power, the FIMI X8 Pro utilizes information such as flight location, surrounding environment, and real-time wind speed to intelligently determine if the current battery level is sufficient. If the battery level is only enough to complete the return journey, Fimi Navi 3.0 will prompt the user whether to initiate the return process. During the return process, pressing the intelligent return button on the remote control can cancel the return. If the user cancels the low battery return warning and continues flying, it may result in insufficient battery power during the return process, leading to a forced landing and potential loss or crash of the drone.

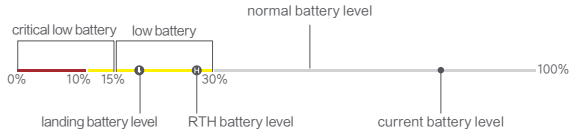

- Inadequate positioning service (such as poor GNSS signal or GNSS failure) may result in the inability to perform a normal return-to-home.
- Before takeoff, it is necessary to enter the safety settings interface of Fimi Navi 3.0 and set an appropriate return-to-home altitude (default is 30m).
- During the return-to-home process, if the environmental conditions, such as low light, do not meet the requirements of the visual system, the drone will be unable to avoid obstacles.
- No-fly zones will affect automatic return-to-home and may result in the inability to complete an automatic return-to-home. Please avoid flying near no-fly zones.
- Strong winds may prevent the drone from successfully returning home. Exercise caution when flying in such conditions.
- Always be aware of small objects (such as tree branches or power lines) or transparent objects (such as glass or water surfaces) along the return-to-home path.
- In case of an emergency, stop the return-to-home process and manually control the drone.

# Intelligent Flight

## Auto Take-off

When the conditions are right, press Auto Take-off/Landing button for 2 seconds or click the “” button in the FIMI Navi 3.0 app. In GNSS mode, the drone will take off to an altitude of 4 meters and hover for sticks control. In VPU mode, the drone will take off to an altitude of 1.2 meters and hover for sticks control.

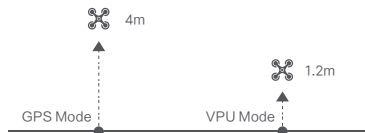

## Auto Landing

When the drone meets the conditions for automatic landing, press and hold the automatic takeoff/landing button for 2 seconds or click the “” button in the FIMI Navi 3.0 app. The drone will descend vertically to the ground from its current position. Press the automatic takeoff/landing button briefly or click the “X” button in the FIMI Navi 3.0 app to exit.

## Auto Return

When the drone is in flight, the user can toggle the auto return switch to the right to return the drone or click the “” button in the FIMI Navi 3.0 app. When the return distance is less than 10 meters and flight altitude is less than 3 meters, the drone will ascend to 3 meters first and return to the home point; if the flight altitude is greater than or equal to 3 meters, the drone will directly return to the home point. When the return distance of the drone is greater than or equal to 10 meters and the flight altitude is less than 30 meters, the drone will ascend to 30 meters and return to the home point; if the flight altitude is 30 meters or more, the drone will directly return to the home point. The user can toggle the Auto Return Switch or click the “X” button in the FIMI Navi 3.0 app to exit.

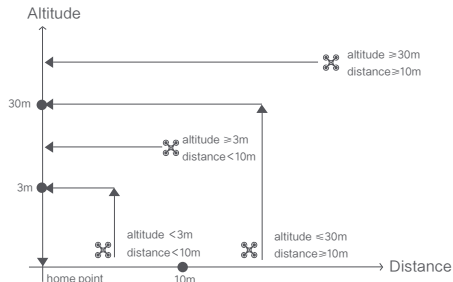

# Smart Track

Follow flight is only supported in GNSS mode. Users can enter the Smart tracking menu by clicking on the “👤” icon in the FIMI Navi 3.0 App. They can then select "Normal Follow," "Parallel Follow," or "Lock Follow." The drone will track the target selected within the app's frame as the tracking target.

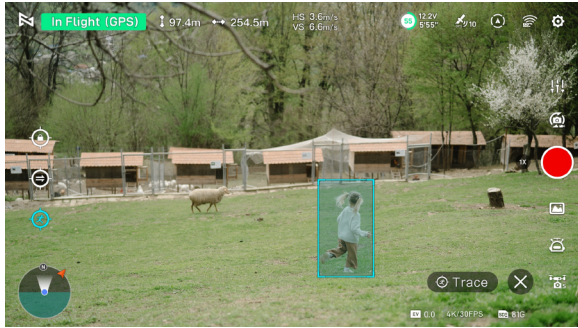

In Trace mode, the heading will always lock at the target and trace it from the back at a distance.



In Profile mode, the heading will always lock at the target and trace it from the side at a distance.

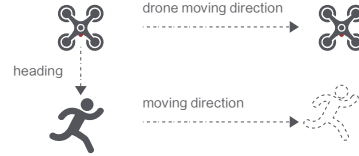

In Lock mode, the drone will hover at a place if flight speed is 0, following the target 360°. The user can also adjust flight speed, and the drone will fly around the target at a certain distance.

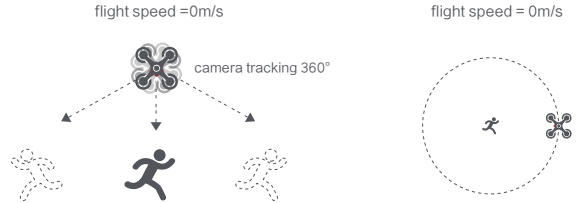

⚠️ In Smart Trace, users should always make sure to avoid people, animals and obstacles in the tracking path to ensure the flight safety. Users should comply with local laws and regulations when using the function.

## Orbit

The user can select Orbit mode in the App. when a central point and a radius are set, the drone will fly around the central point at a default speed. If a point of interest is set, the camera will be locked at the POI.

- Fly to a central point to set the central point.
- Fly away from the central point to set radius.
- Set flight speed, move direction and heading.
- After setting the parameters, click "GO".

During Orbit mode, you can set the direction and speed of the Orbit flight in the Fimi Navi 3.0 app. Click on the "X" button to exit the Orbit mode.

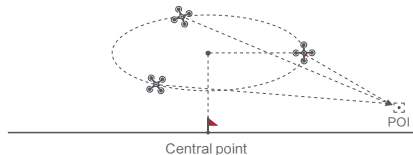
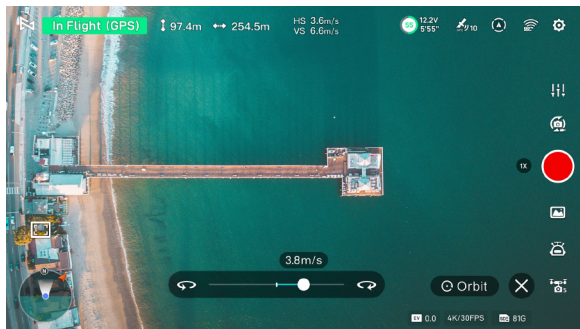

If sticks are moved in flight, the flight altitude or radius will be changed. Taking Mode 2 as example:



## Spiral Mode

The user can select Spiral Mode in the App. Set the central point and radius, the drone will spirally fly upward and shoot a video simultaneously, showing a sense of space.

- Fly to a point to set as the central point.
- Fly away the central point to set radius.
- Set spiral direction and flight distance.
- After setting the parameters, click "GO".

During Spiral mode, click on the "X" button to exit Spiral mode.

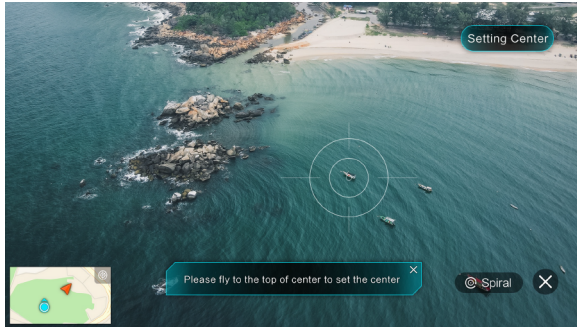
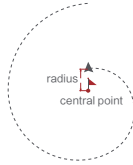

## Tap-fly

The user can select Tap-fly in the App. Tap map to choose a destination and set flight speed, the drone will fly over there at a default speed in a straight line. If a point of interest is set, the camera will be locked at the POI

- Tap map to choose a destination
- Switch to image interface to drag a rectangle around the POI
- Set flight altitude and speed

During Tap-fly mode, click on the "X" button to exit Tap-fly mode.

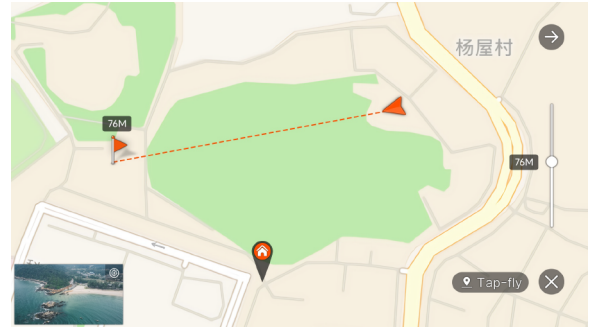

## Dronie

The user can select Dronie, including Rocket and Invert, in the App. In Rocket mode, the drone flies upward with the camera pointing downward at the subject to shoot a video. In Invert mode, the drone flies backward and upward with the camera locking at the subject to shoot a video.

- Select the target by framing it.
- Set the flight speed and altitude.
- Click on "GO" to execute. The drone will automatically calculate the flight time and adjust its position. After a 3-second countdown, the drone will start capturing the desired shots.

During selfie flight, click on the "X" button to exit the selfie flight.

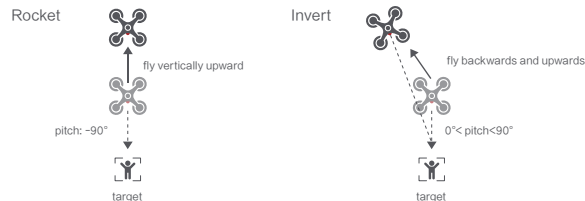

## Course Lock

Users can select the Course Lock mode in the app. The drone will move forward in the current heading direction and lock the direction. By using the joystick, users can change the heading direction and adjust the shooting angle, while the forward direction remains unchanged. Click on the "X" button to exit the Course Lock mode.

## Tripod Mode

Users can select the Tripod mode in the app. The maximum flight speed of the drone is 1m/s, and the maximum rotation speed is 60 degrees/s. In Tripod mode, the sensitivity of the drone is reduced, resulting in a more stable and smooth shooting experience. Click on the "X" button to exit the Tripod mode.

## Aerial Mode

Users can select the Aerial mode in the app. In Aerial mode, the braking distance of the drone increases, and the rotation angular velocity is limited, resulting in smoother and more controlled movements. This mode provides a more stable and fluid shooting experience. Click on the "X" button to exit the Aerial mode.



## Waypoint

Choosing waypoint and drawing route both are available at map. The drone flies along waypoint route at a default speed. If a point of interest is set, the camera will be locked at the POI. The user can select a way to set waypoints, including choosing points in flight or on the map, historical routes.

Choosing points in flight:

- Control the drone to a point to set as a waypoint
- Using sticks to set flight altitude and heading direction, dials to set gimbal angle, and actions when reaching the waypoint
- When all waypoints ready, please set waypoints routes attribute, including flight speed, heading direction, action at the destination
- POI is enabled when executing waypoints

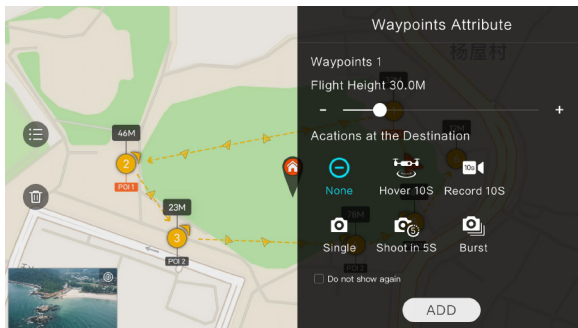

## Choosing points on the map

- Tap map to add waypoint
- Set waypoint attribute, including flight altitude, action at the destination, rotate direction
- Drag the POI icon to the map, and set its altitude and relate waypoints
- When all waypoints ready, please set flight speed, failsafe action, and action at the POI is enabled when executing waypoints

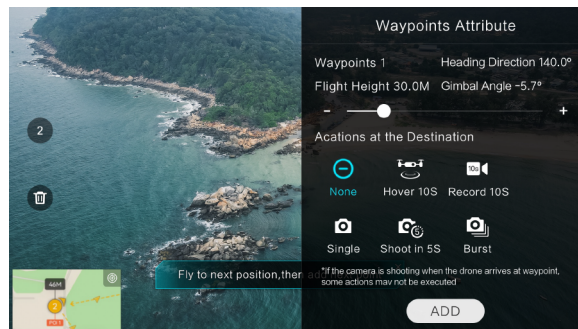

## Historical routes

- preview the waypoints and its attribute by entering Favorite list
- tap to start and show the real-time waypoints trace

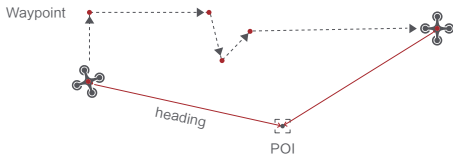

## SAR Mode

The user can select SAR Mode in the APP. With real-time GPS coordinates, the drone could help user to search and rescue.

Image interface: show real-time coordinate and time of the drone, support digital zoom, screen shots to share online

Map interface: show real-time coordinate and time of the drone in ordinary map and satellite map, screen shots to share online

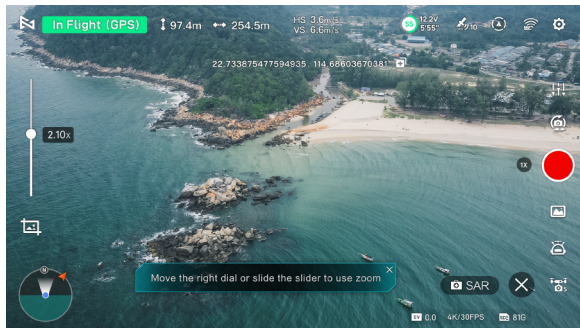

## Precise Landing

In the process of Return to Home, the optical flow sensor will match landing pad features above the home point. Once matched successfully, the drone will land on the landing pad precisely.

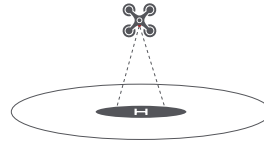

⚠ Please enable precise landing in the app before use it.

## Fix-wing Mode

In Fix-wing Mode, the drone can only fly forward, not backward. The user can use sticks to control flight speed and course as showed below (America Mode).

Left stick	push upward	up
	push downward	down
	toggle left	turn left
	toggle right	turn right
Right stick	push upward	accelerate
	push downward	decelerate
	toggle left	turn left
	toggle right	turn right

## Visual System and Infrared Sensing System

The FIMI X8 Pro is equipped with front, rear, and bottom binocular vision systems as well as a bottom infrared sensing system, providing the drone with environmental perception and positioning capabilities. The front, rear, and bottom binocular vision systems are located at the front, rear, and bottom of the drone, respectively, and each consists of two cameras. The visual systems use image ranging to perceive environmental obstacles. The bottom infrared sensing system consists of an infrared sensor module (transmitter and receiver). The infrared sensor provides the drone with a reference for ground height, working in conjunction with the downward visual system to calculate the drone's position information.

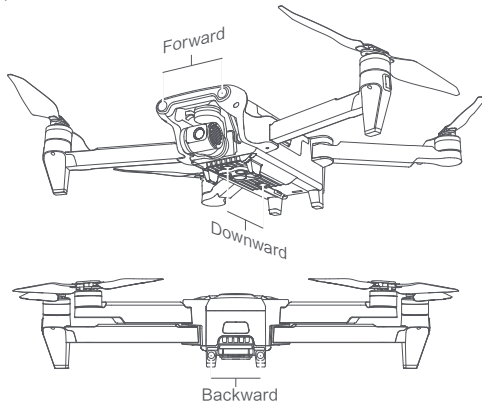

## Calibration:

The automatic calibration of the visual system is already completed during the factory assembly, and it can function properly. During the flight, if the system detects any abnormalities in the calibration parameters, the drone will attempt to perform an automatic calibration. At this time, the FIMI Navi 3.0 App will display relevant prompts. No manual intervention is required from the user during the automatic calibration process, and normal operation is sufficient. If the automatic calibration fails, it will prompt for advanced calibration.

## Sensing range

Forward: Precision Measurement Range: 0.5-14m

FOV: 63° horizontally, 49° vertically

Backward: Precision Measurement Range: 0.6-12m

FOV: 63° horizontally, 49° vertically

Downward: Precision Measurement Range: 0.3-6m

FOV: 65° front to back, 49° left to right

Precise hovering range: 0.5-8 m

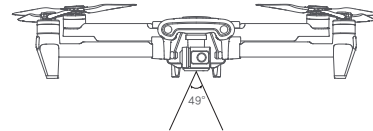

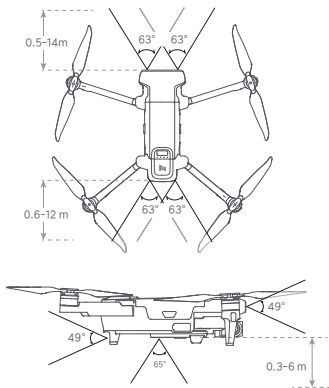

## Usage Scenarios

The positioning function of the downward vision system is suitable for environments with no or poor GNSS signal and is automatically turned on in normal or smooth mode. The forward and backward vision systems are automatically turned on in normal or smooth mode ( need to select obstacle avoidance behavior as go around or brake stop in FIMI Navi 3.0 App). The forward and backward vision systems are suitable for well-lit environments, and the texture of obstacles encountered in the flight path must not be particularly sparse. In addition, due to inertia, the drone needs to be controlled to brake within an effective distance.



Please make sure to pay attention to the flight environment. The vision system and infrared sensing system only play a supplementary role under limited conditions and cannot replace human judgment and control. Users should always pay attention to the surrounding environment and FIMI Navi 3.0 related warnings during the flight, maintain control of the drone and be responsible for the control behavior. The user should be aware of the surroundings and FIMI Navi 3.0 related warnings at all times during the flight, maintain control of the drone and take responsibility for the control. When using the down-sight vision system in an open and flat field without GNSS, the optimal operating altitude range of the vision positioning system is 0.5 - 8 m. When flying beyond this range, the vision positioning performance may be degraded, so please fly with caution.

The downward vision system may not work properly on the water surface. Therefore, when the landing function is triggered, the drone may not be able to actively avoid the lower water. Users are advised to maintain full control of the flight and make reasonable judgments based on the surrounding environment without over-relying on the vision system. The vision system cannot recognize surfaces without textural features and cannot operate properly in environments with insufficient or excessive light intensity.

The vision system does not work properly in the following scenes:

- a) Solid-colored surfaces ( such as solid black, solid white, solid red, solid green).
- b) Surfaces with strong reflections or reflections ( such as ice).
- c) Surface of water or transparent objects.

- d) surfaces with moving objects ( such as above foot traffic, above bushes or grass blown by high winds)
- e) Scenarios with intense and rapid changes in lighting conditions.
- j) Tiny obstacles (such as tree branches, wires, etc.).

Do not obscure or interfere with the visual system in any way, and make sure the lens is clear and free of smudges. Avoid flying in rainy and foggy weather or in other scenes with low visibility (visibility below 80m). Before takeoff, please check the surface glass of the IR sensing system and the vision system:

- a) Remove the surface film, stickers and other obscuring items.
- b) If there are water drops, fingerprints, dirt, etc., please wipe it clean first (please use dust-free cloth).
- c) If there are drops, broken, scratches, abrasion, etc. on the surface, please return it to the factory for repair.

## Assembly and Disassembly

### Propellers

- Unfold the front and rear arms of the drone.
- Attach the gray marked propellers to the motor mounting base with gray marks on the arms.
- Rotate the propeller to the end of the lock direction until the propeller gets bounced and locked.
- Press the propeller forcefully and rotate the propeller along the unlock direction to remove the propeller.

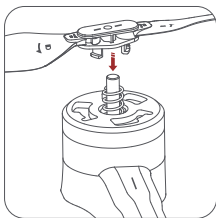

Take the installation of reverse propeller as an example.



- Please use the FIMI supplied propellers, do not mix different propeller models.
- Please check that the propeller is properly installed and tightened before each flight.
- If the propeller is broken, please replace it with a new one to ensure flight safety and efficiency.
- Do not get near the rotating propeller and electric motor to avoid cuts.

- Before each flight, please make sure the electric motor is firmly installed, without other objects in the electric motor and can rotate freely.
- Do not touch the electric motor directly with your hands immediately after the electric motor stops rotating, as this may cause burns.
- Do not block the electric motor ventilation slot.
- Make sure that the ESC beeps after the power is turned on.

### Intelligent Battery

- Push hard the battery, after the battery is installed in place, there will be a "click" sound.
- To remove the battery, you need to press the battery buckle on both sides of the battery to pull out the battery.

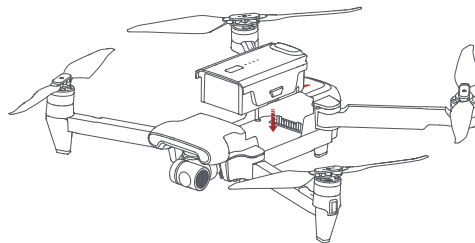

## Drone Micro SD card

- When installing SD card to the drone, please unfold the arms of the drone first and open the protection cover
- Insert the SD card with the head side facing upward into the SD card slot
- When removing SD card, press the SD card to pop it out

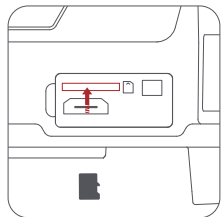

 • Support Micro SD ( U3 and above ) 8 ~ 256GB.

## Intelligent Battery

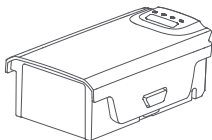

### Intelligent flight battery features

1. Power display: the battery comes with a power indicator, which can display the current battery power.
2. Battery storage self-discharge protection: after fully charged and left for 24 hours without any operation, automatic discharge will start, and the battery will be discharged to 65% power to protect the battery.
3. Balance protection: automatically balance the battery internal cell voltage to protect the battery.
4. Over-charging protection: Over-charging will seriously damage the battery and will automatically stop charging when the battery is fully charged.
5. Charging temperature protection: Charging when the battery temperature is below 5°C or above 40°C will damage the battery, and the battery will stop charging when it is outside the temperature range.
6. Charging overcurrent protection: High current charging will seriously damage the battery, and the battery will stop charging when the charging current is detected to be too large.

7. Over-discharge protection: Excessive discharge will damage the battery. When the battery is not used for flight, the battery will be discharged to a certain voltage when Cut off the output. The battery will not enable over-discharge protection during flight.
8. Short circuit protection: The battery will cut off the output to protect the battery if it detects a short circuit.
9. Cell damage detection: If the battery detects cell damage or serious imbalance, the APP will indicate that the battery pressure difference is too large or the cell is damaged.
10. Communication: The drone can get the battery information in real time through the communication interface on the battery, such as voltage, power, current, etc.

### Check the power level

Short press the power button to check the current power level.

The power indicator can be used to show the power of the intelligent flight battery during charging and discharging, the indicator is defined as follows.



Indicates that the LED is always on



Indicates that the LED is flashing regularly



Indicates that the LED is of



Indicates that the LED is flashing rapidly



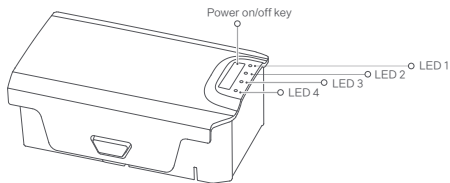

Power level	LED 1	LED 2	LED 3	LED 4
100%	●	●	●	●
75%-99%	●	●	●	●
50%-74%	●	●	●	○
25%-49%	●	●	○	○
0%-24%	●	○	○	○

## Power On and Off

To turn on/off the battery, perform a short or long press on the battery button for more than 2 seconds. When the battery is on, the power indicator light will display the current battery level.



### Precautions for Low-Temperature Use:

- When using the battery in a low-temperature environment (-5°C to 15°C), ensure that the battery is fully charged. The battery's discharge capability is reduced at low temperatures. Before flying, hover the drone to warm up the battery.
- Flying with the battery in an environment below -5°C is not permitted.
- If the APP indicates a low temperature, immediately return and stop the flight, allowing the battery to warm up or reach full charge.
- It is recommended to preheat the battery to above 10°C or even better, above 20°C, in a low-temperature environment before flight.

## Charging

- The power indicator during charging follows the following guidelines:
- Connect the battery, charger, and AC cable as shown in the diagram and turn on the power.
- The battery indicator will flash while charging is in progress.
- When the battery is fully charged, the battery indicator will turn off.
- It takes approximately 2 hours for the smart battery to fully charge.

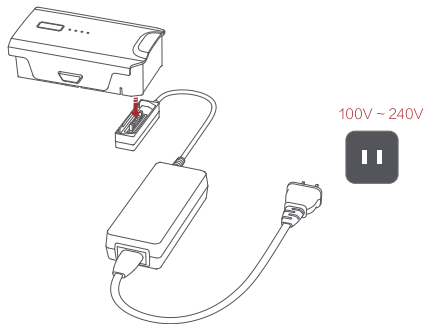

- ⚠️ • After the flight, if the battery temperature is high, it is necessary to wait for the battery to cool down to room temperature or remain idle for 30 minutes before charging
  - The recommended charging temperature range for the smart battery is  $25 \pm 3^\circ\text{C}$ , as charging within this range can extend the battery's life.
  - Recharge and discharge the battery every 3 months to maintain battery activity.
  - Use the official charger provided by FIMI for charging the smart battery. FIMI will not be held responsible for any consequences resulting from the use of non-FIMI chargers.
  - For safety reasons, during long-distance or prolonged transportation, it is advisable to keep the smart battery at a low level, such as below 50%.
- 💡 • For safety reasons, smart batteries need to be kept low (such as below 50%) during long-distance or long-term transportation

The power indicator during charging is as follows:

Power level	LED 1	LED 2	LED 3	LED 4
0%-24%				
25%-49%				
50%-74%				
75%-99%				
Full				

### Charge and Discharge Protection Indication Messages:

The battery LED provides information regarding battery protection triggered by charging anomalies.

Protection	Display definition	LED 1	LED 2	LED 3	LED 4
Over-discharge protection	LED 1,2and LED 3,4 Flashing alternately				
Other protections	Fast flashing				

## Gimbal and Camera

FIMI X8 Pro gimbal is an integrated gimbal that utilizes three-axis mechanical stabilization technology to provide a stable shooting platform for the camera. The pitch axis can rotate within a range of 0-90° and can be controlled using the left scroll wheel on the remote controller or adjusted through the app interface. The camera features a CMOS sensor size of 1/1.3 inches and is equipped with an undistorted lens with a 24mm equivalent focal length, making it easier to capture wide-angle shots.

### Equip and remove the gimbal protector

Equip and remove the gimbal protector as show

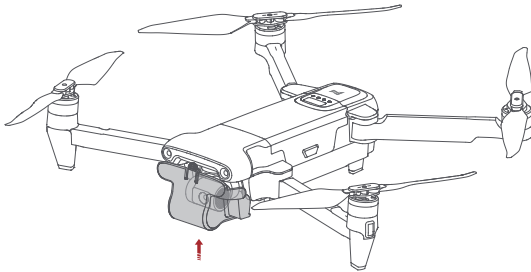

## Gimbal

FIMI X8 Pro combines a light weight 3-axis mechanical gimbal with the latest professional control algorithms and  $\pm 0.005^\circ$  control accuracy, which provides a stable shooting platform for camera. The pitch axis, default to tilt from 0-90°, can be adjusted by left dial of remote controller or App.

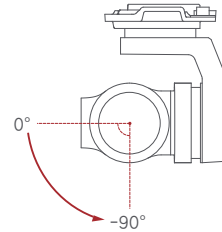

## Operating Mode

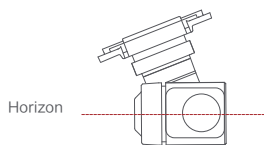

### Follow Mode:

The roll axis does not move with the drone and always keep the gimbal horizontally, which suits for shooting stable videos

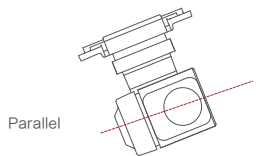

### FPV Mode:

The roll axis rotates with the drone to provide a first person view

- ⚠ Before takeoff, please ensure that the drone is placed on a flat and open ground. Avoid colliding with the gimbal after powering on the drone.
- The gimbal contains delicate parts, and any impact or foreign object interference can result in damage and a decrease in gimbal performance or render it unusable. Please handle the camera head with care to avoid physical damage.
- Keep the camera head clean and avoid contact with sand, magnetic materials, or other foreign objects that may block or affect its performance.
- In the case of the camera placed on potholes or grass, or when the gimbal experiences excessive external forces (such as bumps or jams) from ground objects, the gimbal motor may enter a protected state.
- Do not attach additional objects to the camera head, as this can affect its performance and potentially damage the motor.
- Before turning on the camera, remove the protective cover. During storage or transportation, use the storage cover to protect the camera head.
- To clean the lens surface from dirt or dust, it is recommended to use professional lens cleaning tools to avoid damage and maintain image quality.
- Avoid inserting or removing the SD card while the drone is powered on, as it may damage the card and result in data loss.
- To ensure camera system stability, limit the duration of a single recording session to 5 minutes or less.
- Before shooting, double-check the camera's relevant parameter settings to ensure they are correct.
- When using this device to capture important footage, it is recommended to perform several test shots before the actual recording to ensure that the device is in normal working condition.
- Properly turn off the smart flight battery to save camera parameters and prevent video damage. FIMI is not responsible for any damage caused by unreadable videos or photos.

## Remote controller

With ergonomic design, it is easier and more precise to control. There is no complicated operation to connect App, just plug in and it works. The remote controller fully charged can work about 4.5 hours.

## Turning on and off

- Short press+long press power button 2 seconds to power on/off
- Short press to check battery level

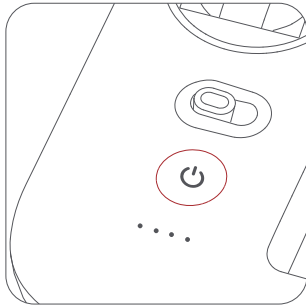

## Charge

- Connect the remote controller to a power adapter as show below
- When the RC is in charge, the battery level lights are flashing
- When the RC is fully charged, the battery level lights go out
- It takes about 2.5 hours to fully charge the RC in the powered off condition

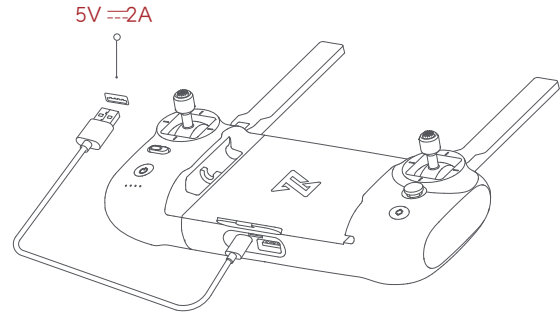

## Assemble Device

- Tighten the mobile or pad on mobile device holder by extending the holder to the left.
- Open the interface protection cover on the RC bottom.
- Connect your phone and the RC with a USB cable.
- Connect the drone and update firmware according to instructions in FIMI App.

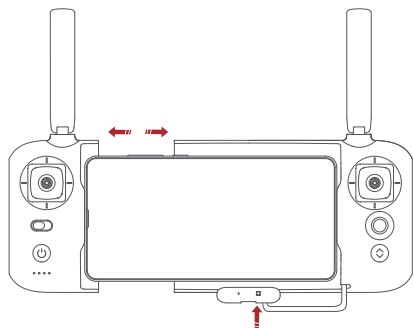

• The cable slot is reserved on the right side of the RC.

## Recording and Photo Shooting

- Press the shoot button to take a photo. A photo is taken when you hear 2 short sounds.
- Press the record button to record video. Recording starts when you hear 2 short sounds. Press again to stop recording with 4 short sounds.
- The pitch angle of the gimbal can be controlled by toggling the left dial up and down.
- The right dial can adjust EV/ISO.

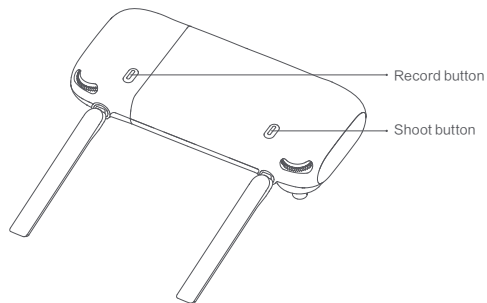

## Shortcut Buttons

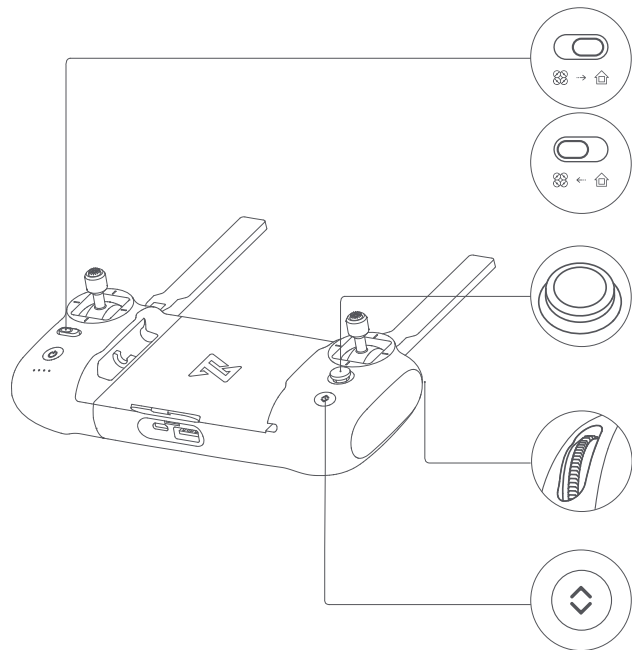

- Toggle the auto return button to the right when the drone is in flight, the drone will return to the home point.

- In the process of auto return, toggle the auto return button to the left, the drone will hover at place and wait for sticks instructions.

- Push the five-directional button up default to access map or FPV

- Push the five-directional button down default to gimbal center or down

- Toggle the five-directional button left default to turn on/off battery info interface

- Toggle the five-directional button right default to turn on/off self-check interface

- Press the five-directional button center default to turn on/off media

- Right dial to adjust EV/ISO value

- Left dial to adjust pitch angle of gimbal

- When auto take-off/land button turns white, it can be pressed to take off or land

- When the drone meets auto take-off conditions, long press 2 seconds to take off

- When the drone meets auto land conditions, long press 2 seconds to land

- When the drone is executing intelligent flight, short press this button to exit

## Sticks Control

### Mode 1

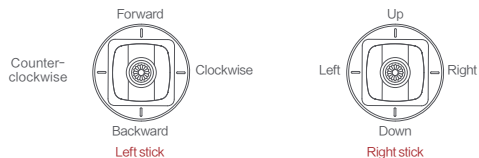

### Mode 2

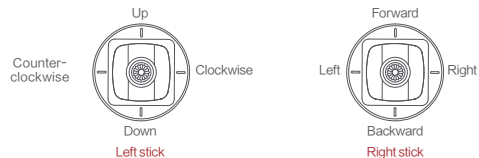

### Mode 3

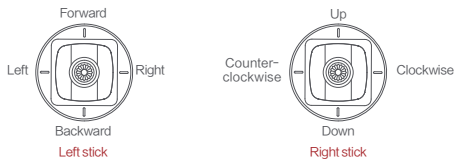

## Remote Controller Pairing

When a new remote controller or drone is replaced, please pair the remote controller and the drone again as shown below:

- Turn on the drone
- Turn on the RC, long press the power button 15 seconds until hearing constant beep sound, and the power button red light flashes
- Short press the code pairing button on the drone, the yellow light on the drone goes out
- The code pairing succeeds when the power button on the RC turns white and the yellow light on the drone keeps on

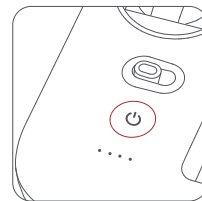
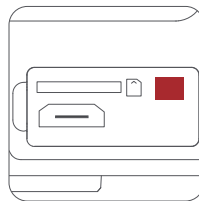



## Remote lights

	Remote lights	Remote status
1	Power button's red light are on	Weak signal
2	Power button's red light flashes	Not connected to the drone
3	Power button's red light flashes	RC Pairing or upgrading firmware
4	Power button's white light is on	Normal signal
5	Power button's white light flashes	Recording videos
6	Auto take-off/landing button's red light is on	Auto take-off or landing not enabled
7	Auto take-off/landing button's white light on	Ready for auto take-off

# APP

After downloading and installing the APP, register the FIMI user account and log in. Click to enter the flight interface, or you can use it without logging in.

⚠️ • Some features, such as flight logs, will not be available without logging in.

## Image Interface

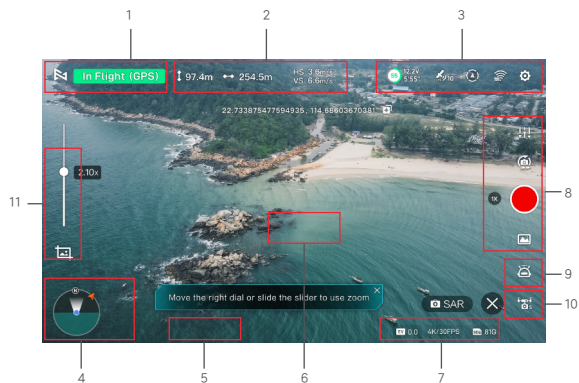

### 1. Real-time Flight Parameters

🏠 : Tap to return to the home screen.

**In flight** : Current flight status

**GPS** : Current flight mode, including GPS, VPU, ATTI

### 2. Drone Status

↕️ 97.4m: Vertical flight altitude from the home point

↔️ 254.5m: Horizontal distance from the home point

**VS 3.6m/s**: Vertical speed

**HS 1.80m/s**: Horizontal speed

### 3. Signal Status and General Settings

📶 : Show GPS signal status, 0-6 indicates poor with red; 7-12 indicates good with yellow; 13 and above indicate excellent with white.

⚙️ : Tap to enter flight control settings

📶 : Show the RC signal strength, tap to enter RC setting

🔋 : The numerical value inside the circle represents the battery power percentage. The adjacent values indicate the voltage and remaining flight time. Click to access battery settings.

🚫 : Displays the status of the obstacle avoidance function, click to enter the obstacle avoidance settings.

#### 4. Attitude ball

 : Displays the drone head orientation, tilt angle, remote control position and other information. Click to switch the map to display the aircraft in real time Location.

#### 5. Megaphone & Dispenser module

After the Megaphone with release-and-drop module is inserted into the aircraft, it will be displayed after powering on.

 : Megaphone

6. Metering Mode: Tap any place in the image interface for metering, when appearing exposure lock button, click to lock the value.

#### 7. Gimbal and Image Parameters

 : Show the current EV value.

 : Camera parameter settings, tap to set EV,ISO,shutter,video or photo mode, resolution, video size, white balance, etc.

 : Show the capacity of SD card and its residue.

#### 8. Camera Operation Area

 : Display the current zoom factor, click to enter zoom settings.

 : Camera parameter settings, tap to set EV,ISO,shutter,video or photo mode, resolution, video size, white balance, etc.

 : Tap to switch between photo and video record.

 : Tap to start/stop shooting photos or record videos.

 : Media library, tap to download or preview videos and photos saved in Micro SD card.

#### 9. Intelligent Flight

Enter the intelligent flight page, where you can perform one-click auto takeoff, landing, and return to home. It supports waypoint navigation, orbit mode, waypoint flight, selfie mode, spiral flight, as well as shooting in tripod mode and aerial photography mode.

 : Auto Take-off

 : Auto Landing

 : Auto Return

 : Waypoints

 : Smart Track, including Trace, Profile, Lock

 : Orbit

 : Tap-fly

 : Dronie,including Rocket and Invert

 : Spiral Mode

 : SAR Mode

 : Aerial Mode

 : Tripod Mode



 : Course Lock

 : Fix-wing Mode

## 10 Drone gear mode





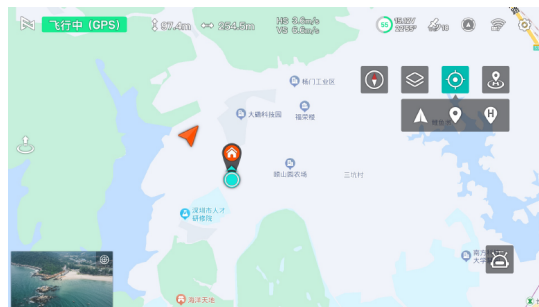

-  : Display the current aircraft gear mode, click to switch between "Sport" "Normal" "Cine" mode
- Sport: Max horizontal speed 18m/s, Max ascent speed 5m/s, Max descent speed 4m/s
  - Normal: Max horizontal speed 10m/s, Max ascent speed 4m/s, Max descent speed 3m/s
  - Cine: Max horizontal speed 6m/s, Max ascent speed 1.5m/s, Max descent speed 1.5m/s

## 11. Shortcuts

-  : Tap to auto takeoff.
-  : Tap to auto land the drone.
-  : Tap to return the drone.

## Map Interface



-  : Tap to center the drone.
-  : Display the location of the drone.
-  : Display the location of the Home.
-  : Display the location of the phone.
-  : Tap to correct the direction.
-  : Switch the map.
-  : Home point.

## Fly

### Confirm the drone heading

- The direction of integrated gimbal camera is the drone heading.
- Once the drone is turned on, the heading can be told by navigation lights.
- The red light and the green light indicate the heading, and the yellow light is the tail.

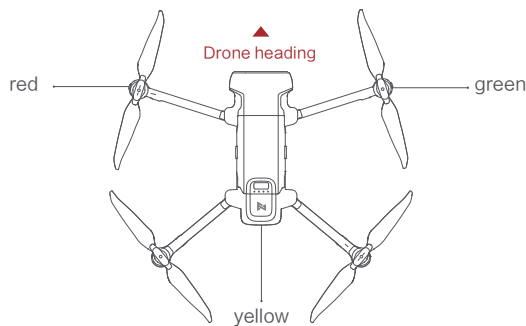

⚠ • Always keep the tail pointed at the user to avoid direction misjudging.

### Pre-flight inspection

- Make sure the battery of the aircraft and the remote control are fully charged.
- Make sure that the propeller is installed correctly and that the propeller is not damaged or deteriorated.
- Make sure the camera lens is clean.
- Make sure the SD card is inserted.
- Make sure the front and rear propellers are extended in place
- Whether the camera and gimbal work normally after powering on
- Make sure the FIMI Navi 3.0 is running normally

### Automatic take off / landing



### Manual take off

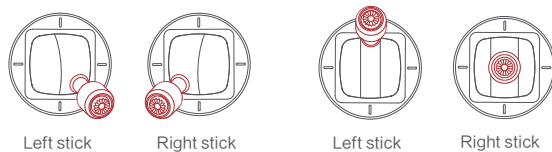

- ⚠ • Keep both sticks to the bottom inner still over 3 seconds, the propellers start spinning.
- Release both sticks once propellers have been spinning, and firmly push the left stick upward to take off the drone.
- During flight, release both sticks to hover
- At any time during controlled flight, release the sticks and the drone will hover automatically.
- 💡 • When pushing the left joystick upward to take off, it is necessary to be decisive. Pushing the left joystick too slowly may cause the aircraft to tilt and flip.

## Manual take landing

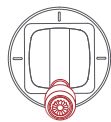

Left stick



Right stick

- Slowly move the left stick downward to land the drone
- Once the drone has landed, push and hold the left stick down over 5 seconds, the motors will stop

## Stop propellers in an emergency

When motors can't properly turn off, please toggle the left stick to the bottom inner in maximum range, and press Auto take-off/landing button for 5 seconds simultaneously, the motors will stop.

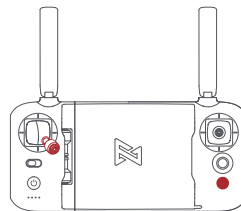

- 💡 • Do not do the above operation during normal flight to avoid motors being stopped in the air.

## Flying Condition Requirement

1. The drone is suitable for people above 18 years who have full civil capacity.
2. Make sure to keep some distance from people, animals, trees, vehicles and buildings while using the drone. Please be careful when someone approaches.
3. Keep away from airports, railways, highways, high-rise buildings, utility poles and other dangerous environments when operating the drone.
4. Keep away from the areas with complex electromagnetic signals such as communication base stations and high-power antennas when operating the drone.
5. The flight altitude and distance of the drone corresponding to the take-off point will be limited based on relevant regulations and policies.
6. Do not use this product at the place and time prohibited by regulations and policies.
7. To protect the legitimate rights and interests of users, please follow the product safety instructions when using.
8. Do not operate the drone in bad weather such as strong winds, rain, snow, or fog.
9. Please operate the drone in a broad place with a good GPS signal.
10. It is suggested that user should make the first flight under the guidance of an experienced pro.

# Maintenance and Calibration

## Remote Controller Calibration

Please try to calibrate the remote controller when you detect inconsistencies between stick control and drone flying.

- Select "RC Calibration" in the remote controller menu.
- Tap "Start" to calibrate the center, do not move sticks .
- Skip to sticks calibration once the center calibration succeed.
- Skip to dial calibration once the sticks calibration succeed.

 • Please turn off the power of the drone before calibrating the remote controller. RC calibration is not available in flight.

## Compass Calibration

The compass may need to be recalibrated when there are changes in the magnetic field to ensure proper flight. If the aircraft requires compass calibration, the app will provide corresponding prompts.

- Open the app and access the system settings.
- Scroll down the menu and select "Compass Calibration," then tap to enter calibration mode.
- Follow the on-screen animation prompts and rotate the aircraft accordingly.
- When the screen displays "Calibration Successful," the compass calibration is complete.

 • Please connect the drone before calibration. Compass calibration is not available in flight.

## Gimbal Calibration

- Click "gimbal calibration" and enter the calibration page in the gimbal settings menu.
- After the drone is placed smoothly, click to start calibration. Do not move the drone during the calibration process.
- After the calibration is completed, the App interface shows "Calibration succeed".
- If the App interface shows "Calibration failed", please recalibrate.

## Flight Data

The FIMI X8 Pro flight control is equipped with a flight logging function, which stores all relevant data after the drone is powered on in the flight control system. The FIMI Navi 3.0 App also has a flight logging function, allowing users to save or delete the related data locally at their discretion.



## Propellers Maintenance

Propellers are wearing parts. When they're damaged, replace them in time to ensure flight safety and efficiency.

## Battery Maintenance

Do not throw the battery into fire; Do not batter the battery; Lithium battery's capacity reduces significantly in low temperature conditions. Do not use the battery when it is below 5 degrees. Do not place the battery under the burning sun.

## Gimbal Maintenance

The gimbal of the FIMI X8 Pro is an integrated unit and does not require disassembly. When storing the aircraft, please be careful not to scratch or collide with the camera, and pay attention to keeping the camera clean.

## Drone Self-check

The drone enters the self-check when the drone is powered on. If the self-check failed, App will pop up corresponding hints.

## Firmware Upgrade

1. Turn on the drone and the remote controller, and connect the drone to the remote controller. Run the Fimi Navi 3.0 App. Follow the prompts in the Fimi Navi 3.0 App to download the firmware. Internet connection is required during the firmware download.



2. Once the firmware download is complete, the Fimi Navi App will prompt for the upgrade.
3. When upgrading the remote controller, simply connect it using a USB cable.



Remote control connected

Before upgrading, please ensure a stable connection between your phone and the remote control, keep the app active, and the upgrade process may take 2-10 minutes.

**Optimized upgrade content:**

1. X8 Pro – Remote Controller  
Enhanced control effectiveness  
Fixed some issues

Start upgrade

4. When upgrading the drone, use the provided OTG cable to connect one end of the USB cable to your phone and the other end to the drone.

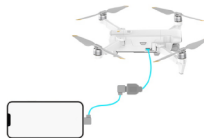

Aircraft Firmware Upgrade

Before upgrading, please ensure a stable connection between your phone and the remote control, keep the app active, and the upgrade process may take 2-10 minutes.

**Optimized upgrade content:**

1. X8 Pro – Camera  
Optimized camera exposure effect  
Fixed some issues
2. X8 Pro – Aircraft  
Improved remote control performance  
Fixed some issues

Start upgrade

💡 For phones with different interfaces, please use the corresponding USB connection cable.

5. After the upgrade is complete, disconnect the data cable connected to the drone, and use a USB cable to connect the remote controller and the mobile phone..

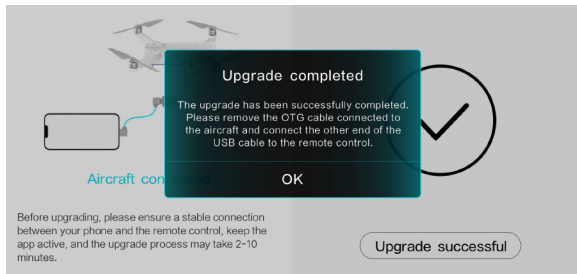

- ⚠ • Make sure to follow the firmware upgrade steps, otherwise, it may result in a failed upgrade.
- The entire upgrade process will take approximately 10 minutes.
- During the upgrade process, the drone may experience the following conditions: gimbal power loss, abnormal flashing of status indicators, or self-restart of the drone. These are all normal phenomena. Please wait patiently for the firmware upgrade to complete.
- Ensure that your personal computer has internet access throughout the entire upgrade process.
- Make sure the drone has a battery level of at least 50% and the remote controller has a battery level of at least 40% before upgrading.
- Do not plug or unplug the USB data cable during the upgrade process.

## Basic Specification

### Drone

Product model: FMWRJ03A9  
Dimensions: 204×106×72.6mm  
Diagonal size: 372mm  
Take off weight: Smart battery about 780g/The intelligent flight battery plus about 830g  
Max ascending speed: 5m/s  
Max descending speed: 4m/s  
Max flight speed: 18m/s  
Satellite positioning systems: GPS/BEIDOU/Galileo/GLONASS  
Operating temperature: 0°C ~ 40°C  
Suitable altitude(Intelligent Flight Battery): ≤5000m  
Suitable altitude(Intelligent Flight Battery Plus): ≤4000m  
Operating frequency: 2.400-2.4835GHz

### Charger

Rated input: 100-240V 50/60Hz 1.45A  
Rated output: 17.6V --- 3.5A  
Rated power: 61.6W

#### Note:

Remote control distance reach to 15km (FCC) in open area and no interference . All above testing and data come from FIMI laboratory, errors may occur in actual use for operating and environmental changes.

### Remote controller

Net weight: About 373g  
Dimensions: 203.8×91×46.6mm  
Operating frequency: 2.400-2.4835GHz  
Type: Rechargeable lithium battery  
Capacity: 3900mAh  
Nominal voltage: 3.7V  
Input: 5 V --- 2A  
Max transmission distance: About 10000m\*  
Operating temperature: 0 ~ 40°C  
Suitable altitude: ≤5000m

### Gimbal

Controllable rotation range: 0°~ -90° (Pitch)  
Angular vibration range: ± 0.005°  
Lens: FOV 85°  
Camera aperture: f1.7  
Camera focal distance: 6.81mm  
Equivalent focal distance: 24mm  
Sensor: 1/1.3" CMOS  
Effective pixels: Max 4800W  
ISO range: 100 - 6400  
Shutter speed: 32 ~ 1/8000s  
Max video resolution: 3840 x 2160 | 30fps | 25fps | 24fps  
Max bitrate: 100Mbps  
File system: FAT32/exFAT  
Image format: JPG/DNG  
Video format: MP4(H.265)  
Memory card type: Micro SD8 ~ 256GB  
( Class 10 or U3 and above )

## Intelligent Flight Battery

Type: Li-Po 4S

Weight: About 280g

Capacity: 3800mAh

Voltage: 15.4V

Limit voltage: 17.6V

Energy: 58.52Wh

Operating temperature: 0°C ~ 40°C

## Intelligent Flight Battery Plus

Type: Li-Po 4S

Weight: About 330g

Capacity: 5000mAh

Voltage: 14.8V

Limit voltage: 16.8V

Energy: 74Wh

Operating temperature: 0°C ~ 40°C

## MTOM Statement

FIMI X8 PRO is a quadrotor drone. The Maximum Take-Off Mass (MTOM) of FIMI X8 PRO (Model:FMWRJ03A9) is 780g including the FIMI X8 PRO Intelligent Flight Battery, propellers, and a microSD card.

This device complies with Part 15 of the FCC Rules. Operation is subject to the following two conditions:

- (1) this device may not cause harmful interference, and
- (2) this device must accept any interference received, including interference that may cause undesired operation.

FCC warning:

Any Changes or modifications not expressly approved by the party responsible for compliance could void the user's authority to operate the equipment.

Note: This equipment has been tested and found to comply with the limits for a Class B digital device, pursuant to part 15 of the FCC Rules. These limits are designed to provide reasonable protection against harmful interference in a residential installation. This equipment generates uses and can radiate radio frequency energy and, if not installed and used in accordance with the instructions, may cause harmful interference to radio communications. However, there is no guarantee that interference will not occur in a particular installation. If this equipment does cause harmful interference to radio or television reception, which can be determined by turning the equipment off and on, the user is encouraged to try to correct the interference by one or more of the following measures:

- Reorient or relocate the receiving antenna.
- Increase the separation between the equipment and receiver.
- Connect the equipment into an outlet on a circuit different from that to which the receiver is connected.
- Consult the dealer or an experienced radio/TV technician for help.

The device has been evaluated