



FIMI TX10 User Manual & Disclaimer

Please read the user manual &Disclaimer carefully before using and keep it for future reference.

Disclaimer and Warning

Thank you for purchasing this product. In order to protect your legitimate rights and interests, please read the Quick Start Guide, Disclaimer, and Safe Operating Guidelines provided with this product carefully before using this product. FIMI Technology Co., Ltd. (hereinafter referred to as FIMI Technology) reserves the right to update the related guides and documents. Before setting up and using this product, please visit the official website of fimi (<http://www.fimi.com>) to download the manual and read it carefully

1. FIMI Technology does not take up any responsibility for any consequences caused by purchasing and maintaining this product through unofficial channels.
2. Once you start to use this product, it is deemed that you have read, understood, approved and accepted the instruction manual, quick start guide, disclaimer and safe operation guidelines of this product.
3. In the process of using this product, please be sure to strictly abide by and implement the requirements including but not limited to the instructions and safety instructions. FIMI Technology is not responsible for the adverse consequences caused by not following instructions manual or tutorial videos.
4. For any personal injury, accident, property loss, legal dispute, and other incidents caused by the violation of the safety instructions or the force majeure factors, all unfavorable events that cause conflicts of interest shall be borne by the users. FIMI Technology will not bear any responsibility.
5. FIMI Technology will not bear any responsibility for any violation of laws and regulations that occurs directly or indirectly by the user using this product.

6. Do not modify this product without authorization, and if resulting in property loss and personal injury, FIMI Technology will not bear any compensation and legal responsibility.
7. When the propeller rotates at high speed, it may cause serious injury to the human body. To ensure user safety, please turn off the power of the drone when operating the propellers. The legal responsibility caused by ignoring this article shall be borne by the user.
8. Relevant national laws and regulations could restrict the flight zone. Before flying this product, users should understand the relevant local regulations. The user shall bear all the responsibilities for the relevant legal liabilities arising from non-compliance with the above provisions.

Operation guidelines

1. The drone is dangerous to a certain extent and is not suitable for use and operation by persons under the age of 18 and other persons who do not have full capability of flying and operating this product.
2. Please make sure to keep a certain distance from people, animals, trees, vehicles and buildings when the drone is in use. When someone approaches, please handle with care.
3. When operating the drone, please keep away from dangerous environments such as airports, railways, highways, tall buildings and poles.
4. When operating the drone, please stay away from telecommunication stations, high-power antennas and other areas with complex electromagnetic signals.

5. The flight height and flight distance of the drone relative to the take-off point will be limited according to relevant laws and policies.
6. Do not use this product at a place and time where the use of this product is prohibited by regulations and policies.
7. In order to protect the legal rights and interests of users, please ensure that you follow the product safety instructions during the use and operation.
8. Do not fly in bad weather such as in strong wind, rain, snow, fog, etc.
9. Please choose a place with good GPS signal and open environment to fly.
10. It is recommended that the user takes the first flight under the guidance of an experienced user.

Product description

The Fimi remote control with screen has built-in third-generation RokLink high-definition digital image transmission system, which is compatible with FIMI X8 SE 2022 and subsequent drone products. It can achieve a control distance of up to 10km at 1080p 30 FPS with the transmission low delay. The remote control comes with a built-in 5.5-inch of 1920x1080p touch screen, the highest brightness can reach 1000cd/m², and support Android 9.0, 4G, Wi-Fi and satellite positioning functionality.

Buttons and functionality of the remote control

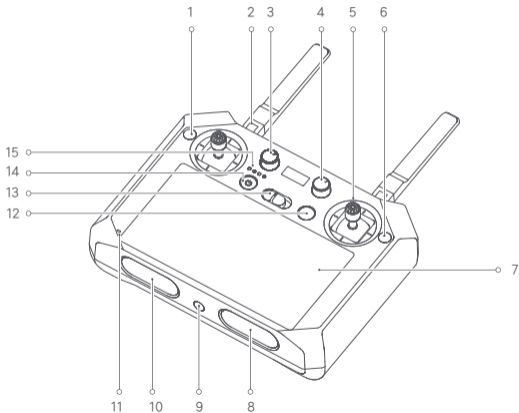

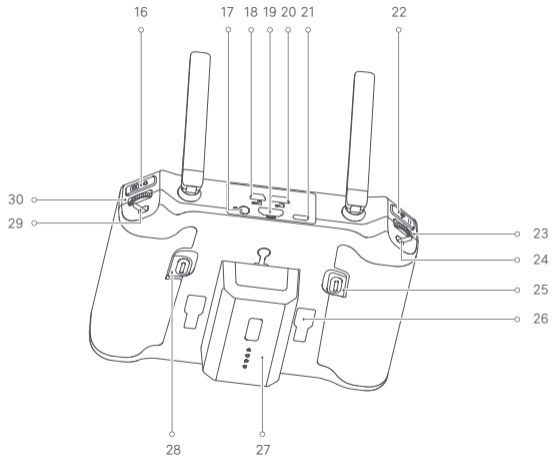

1. Custom button: The system defaults one click to return to the menu, double click to return to the main interface (Home button function), and long press for 2 seconds to display all the applications in use. (Identifier: C1)
2. Antenna: Transmit control signal and video image
3. Scale knob: Logo silkscreen AUX1
4. Scale knob: Logo silkscreen AUX2
5. Flight control joystick: The system defaults to the Mode 2 (U.S. setup)
6. Custom key: Fn composite function (identification: C2):
 1. Zoom: C2+Right wheel
 2. Pairing: Press and hold C1+C2 for 5 seconds at the same time. When entering the pairing, the battery indicator will be in the form of a marquee until the pairing is successful. If the pairing fails within 60 seconds, the pairing mode will be exited
 3. Forced shutdown: Press and hold the power button for 8 seconds
7. Display: Touch screen, screen size is 5.5-inch, resolution 1920*1080p, maximum brightness 1000cd/m²
8. Speaker: For playing the system voice, key prompt tone
9. 1/4" screw hole: For remote control to fix tripod
10. Cooling holes: For cooling the remote control
11. Microphone
12. Drone light control buttons: Long flight light, fill light custom button (short press to turn on/off the auxiliary light, long press for 1.5 seconds to turn on/off the long flight light)

13. Airplane mode switch button: Three modes, from left to right: smooth, normal, sport
14. Power button: Short press then long press for 1.5 seconds to turn on the remote control. When the remote control is on, press it to turn on/off the screen; when the power is on, long press for 1.5 seconds to shutdown/restart
15. Indicator light: Displays the current power level of remote control and current status
16. Photo and video recording buttons: Short press for the Photograph or recording, long press for 1.5 seconds to switch between photo/video recording
17. External microphone jack: Supports ordinary 3.5mm earphones
18. SIM card slot: Standard SIM card
19. HDMI port: Output remote control screen
20. Micro SD card slot: Supports up to 128G
21. Type-C interface: The user can charge the remote control while using. It can be connected to a computer to upgrade the firmware of remote control
22. Pause and return button: Short press to pause, long press for 1.5 seconds to return
23. Roller: By default it controls the pitch angle of the gimbal, or can be customized for third-party gimbal's pitch or yaw angle control, marked with C7
24. Custom DIP Switch: Mark C3

- 25. Custom button: Mark C5
- 26. Joystick compartment : Joystick can be disassembled and stored here (the joystick needs to be taken out from here for the first use)
- 27. Spare battery: Spare battery increases the battery life of the remote control (spare battery is optional)
- 28. Custom button: mark C6
- 29. Custom DIP Switch: Mark C4
- 30. Roller: The default state can adjust the EV/ISO value of the camera, and can be customized for third-party payload gimbal's pitch or yaw control, marked with C8

Function definition of remote control indicator lights (four white lights)

The light is always on in normal state, and the light will flash when abnormal	
Short press the power button when the power is off	Check the battery
1+Beep <10%, 1≤25%, 2≤50%, 3≤75%,4>75%, always on	Battery indicator
Flashing slowly	drone not connected
4 lights are flashing in turn	Remote control pairing or software upgrade
Always on	Communication is normal

Basic parameter information

Image transmission	
Operating frequency	2400-2483MHz
The maximum control distance	10 Kilometers
Storage space	ROM 16GB+ expandable (up to 128G)
SIM card	All telecom (China): LTE-FDD B1/3/5/8 LTE-TDD B34/38/39/40/41 WCDMA B1/8
Video output interface	HDMI
Audio output interface	Standard 3.5mm audio port
Built-in battery	Li-ion battery (4800mAh-7.2V)
Spare battery (optional)	Li-ion battery (4800mAh-7.2V)
Charging way	Charging method QC fast charge, support 12V/9V/5V
Rated power	20W
Charging time	2 .5hours (Use 9V USB charger)
Battery life	4 hours

Charging ambient temperature	0-40°C
Working environment temperature	-10-60°C
GNSS	GPS, GLONASS, BEIDOU

Charge and view battery level

- Please fully charge the remote control before using it for the first time.
- The built-in battery of the remote control will enter the sleep mode as the factory default , please charge and activate it before use.
- Using the recommended charger. Charging time takes about 2.5 hours (9V charger).

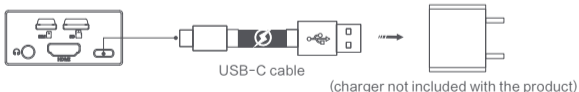

- Check the battery: Short press the power button when the power is off.
- Power on: Short press then long press for 1.5 seconds to turn on the remote control.
- Power off: Long press 1.5 seconds to pop up the shutdown option, click the shutdown option to shut down.

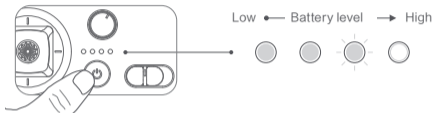

Preparation before use

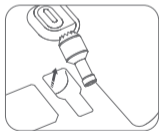

Take out the joystick

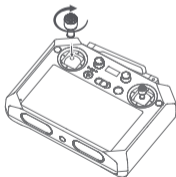

Install the joystick



Unfold the antenna

In order to ensure the best transmission, the angle of the antenna should be in accordance with the flight environments.

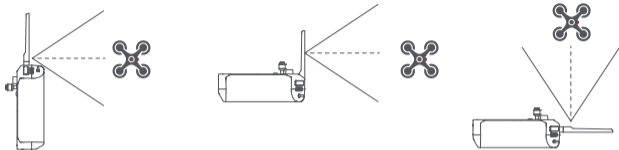

Activation

When using the remote control for the first time, please follow the instructions on the screen.

Connect the drone

In the standard package, the drone and the remote control are already paired by default. When the drone and the remote control are turned on, they will be automatically connected.

Pairing

After turning on the drone and the remote control, long press the pairing button of the drone until the tail light goes off, the drone enters the pairing state, and then long press the remote control C1+C2 at the same time. After pressing the buttons for more than 5 seconds, the remote control enters the frequency pairing state. After a few seconds, the tail light of the drone will be turned on again, indicating that the pairing is successful.

Sticks Control

Mode 1

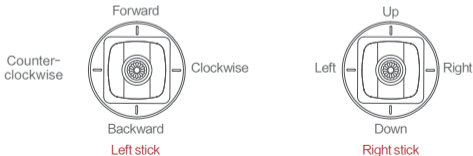

Mode 2

Counter-clockwise

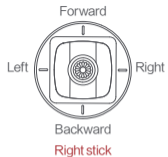
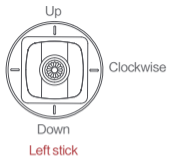

Mode 3

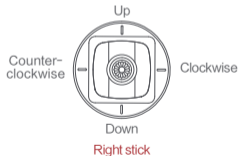
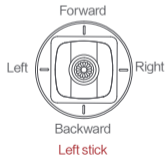

3. FIMI Navi 2.0

After downloading and installing the APP, register a FIMI user account and log in, click to enter the flight interface, you can also use it without logging in.

Note: You will not be able to enjoy some functions without logging in, such as flight recording, etc.

Connect to the APP

X8SE 2022



Further and Clearer

ENTER DEVICE

After launching the APP, click "Enter Device" to enter the main interface of the APP, and the option box "Do you want to allow Fimi Navi2.0 to access rc? Click "OK" to connect.

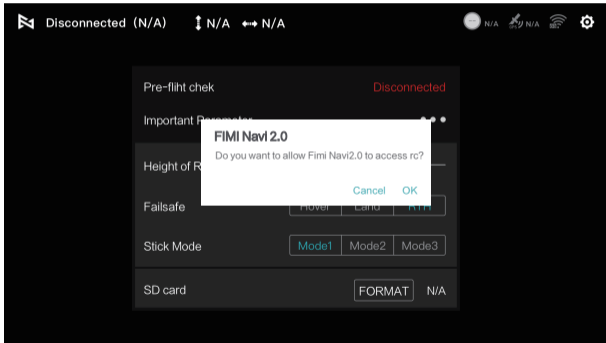

Image transmission interface



1. Drone status

In flight: Displays the current status of the drone

GPS: Displays the current flight mode of the drone, including GPS, VPU, ATTI

S: Displays the current sport mode of the drone

 : Click to return to the interface

2. Real-time flight parameters

110m: The vertical height between the current position of the drone and the Home point

111m: The horizontal distance between the current position of the drone and the Home point

VS 3.6m/s: The current vertical flight speed of the drone

HS 6.6m/s: The current horizontal flight speed of the drone flight

3. Signal status and general settings

 : Displays GPS signal strength, 0-6 in red for weak signal; 7-12 in yellow for medium signal; 13 or above in white for good signal

 : Displays the signal strength of the connection between the remote control and the aircraft, click to enter the remote control settings

 : Displays real-time battery level, click to enter battery settings

 : Click to enter settings

4. Camera operation

3:26: Video duration



: Switch the current mode of the camera between taking photos or video recording



: Take a photo or start video recording, or stop video recording



: Media library, enter to download or view the video and photos stored on the Micro SD card inserted in the aircraft



: Displays Current zoom factor or adjust zoom

5. Intelligent Flight

Entering the Intelligent Flight page, you can perform one-key automatic take-off, landing, return, pointing flight, orbiting flight, route flight, Selfie, spiral flight, and shooting in tripod mode and aerial photography mode



: One-key take-off



: One-key landing











: One-key return



: Route flight, including flight setting, map setting and historical routes



: Smart mode, including normal follow, parallel follow and locked follow

-  : Flying around the point
-  : Pointing flight
-  : Selfie flight (vertical selfie, customized selfie)
-  : Helical flight
-  : SAR mode
-  : Aerial mode
-  : Tripod
-  : Course lock
-  : Fixed wing

6. Image parameters and settings

 : For more parameter settings of the camera, click to set the video or photo modes, resolution, image sizes, white balance, styles, etc

 29.7G : Displays the remaining capacity of the SD card and the total capacity of the SD card

4K/30: The current video resolution/frame rate in video mode, or the image size in photo mode

 100 : Displays the current ISO value

 Auto: Displays the current shutter parameters

7. Accessory module – megaphone and release-and-drop module

 : Open the megaphone function, click to enter to use real-time shouting or other functions

 : Open the release-and-drop function, click to enter the control module to lock and unlock

8. Small map window

 : Displays the aircraft position in real time, click to switch to the map interface

9. Flight shortcuts

 : One-key automatic takeoff

 : One-key automatic landing

 : One-key return

4. Remote control setups

- Remote control calibration: Click "Calibrate" on the remote control setting interface to enter the remote control calibration interface, and follow the corresponding prompts to complete the calibration.
- Remote control customization: You can customize the shortcut functions of the corresponding buttons and knobs on the remote control.
- Reset remote control parameters: Click to restore the default parameters of the remote control.

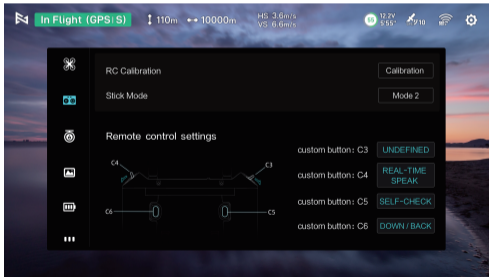



In Flight (GPS/S)

↑ 110m ↔ 10000m

HS 3.6m/s
VS 6.6m/s

55

12.2V
5'55"



custom knob: AXU1

UNDEFINED

custom knob: AXU2

UNDEFINED

Remote control shortcut operation

Remote control pairing : press and hold C1+C2 for 5 seconds at this time

Zoom: C2+right scroll wheel

重置遥控器参数

Application upgrade

To upgrade the APP through the Internet, open the FIMI Navi2.0 APP, click "Upgrade Now" to enter the download and upgrade interface. *If there is a new version of the APP, the upgrade entry will pop up on the first interface of the APP.



X8SE 2022



Less, Yet More

New version is online!

● Upgrade

New firmware found

ENTER DEVICE

5. Peripheral port/slot

HDMI

TX10 has the function to connect to an external HDMI display, which can synchronize the screen image to the display in real time. The port is a standard HDMI A type, which supports up to 1920*1080@60fps image output. The display with HDMI should have the minimum 1920*1080P resolution display capability.

SIM card

TX10 supports 2G, 3G, 4G communication, and supports SIM cards of China Mobile, China Unicom and China Telecom. The SIM card slot is a standard nano card slot. The specific supported formats are as follows:

Network	
LTE-FDD	B1/3/5/8
LTE-TDD	B34/38/39/40/41
WCDMA	B1/8
GSM/EDGE	900/1800MHz

SD/TF card

The memory card slot on the front of the TX10 remote control supports reading and writing high-speed SD/TF cards. Please pay attention to the following when using:

1. The memory card should be handled as gently as possible, and should not be dropped, bumped, pinched, etc. that could cause damage; avoid getting contact with heat, high humidity, strong magnetic field, strong electric field.
2. When using a memory card, try to avoid directly taking out the card.
3. It is best not to use the flash memory card to write or read data when the TX10 remote controller is about to run out of battery, or when the battery level is low.
4. In the process of using the memory card, make sure there is enough remaining card capacity.
5. Be aware of any possible virus infection.
6. Try to avoid using any card with the TX10 remote control if the card has been used on a device that does not meet the specifications.
7. After the system is refreshed and the SD card is inserted for the first time, when selecting the memory card setting from the drop-down menu, please select "For Portable Storage Device", not "For Additional Storage Space, Format Memory Card".

8. When inserting a memory card with bad blocks or an NTFS-formatted memory card, select the memory card setting from the drop-down menu, DON'T select "For additional storage space", please select "For Portable Storage", when "Is this SD card formatted?" option box pops up, please select "Format SD card". Please do not take out the memory card during the process of formatting, it may cause card abnormality.

Audio jack

TX10 has audio input and output function, the interface is a standard 3.5mm audio jack, and supports external microphone audio input.

WIFI

TX10 supports 2.4G and 5G WiFi communication functions of 802.11 a/b/g/n/ac standard protocol.

6. Operating system

Language selection at first boot



: Click to enter language selection



: Click to enter the main interface

Hello, Welcome to FIMI TX10

English (United States)



Suggested

Chinese (China)

All languages

Afrikaans

Aghem

Akan

System desktop

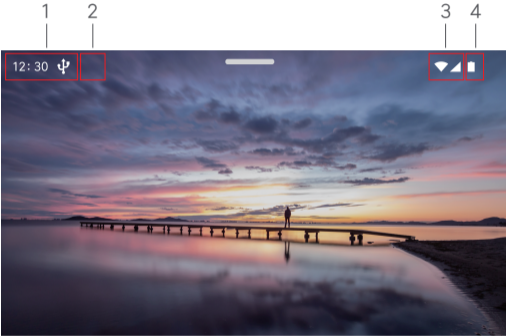

1. Time

View the current time.

2. USB

Connect the computer via USB cable to transfer files, and copy the files on the remote control to the computer.

3. Network signal status indication

Displays the network signal strength after connecting to Wi-Fi or inserting a SIM card. It can be turned on or off using the drop-down menu or through system settings.

4. The battery level of the remote control

Displays the remaining battery power of the current remote control.

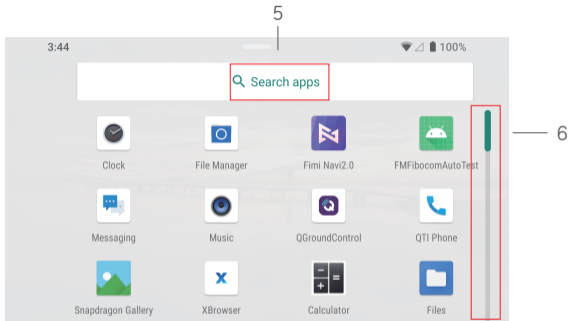

5. Search apps

Click to enter the search bar.

6. Interface slider

When there are many applications in the interface, pull down the slider to display the remaining applications.

Quick Panel Interface

Pull down from the top of the screen to enter the Quick Panel interface.

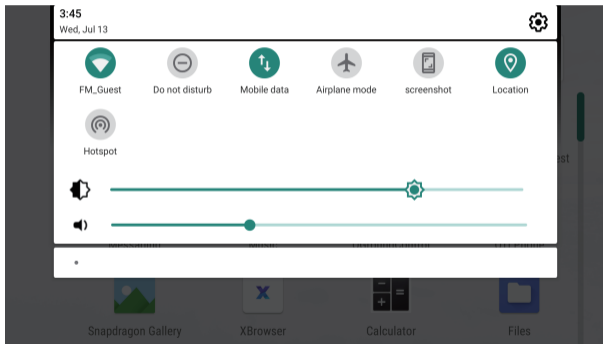

Navigation bar

Swipe left on the far right side of the screen to pop up the navigation bar.



- : Displays the applications opened in the background, corresponding to pressing and holding the C1 button for 1.5 seconds; on this interface, you can also close the APP by swiping it up
- : Return to the main interface, corresponding to double-pressing the C1 button
- ▷ : Return to the previous menu, corresponding to press the C1 button

Install third-party apps

TX10 supports installing third-party Android apps through SD card and app store.

Notice: Too many Android app downloads and installations will affect the smoothness of the operation of the device.

7. Firmware upgrade

- Power on the remote control, and make sure that remote control's network connection is normal.
- Open the FIMI Navi2.0 App, if the remote control has a version update, the upgrade entry will pop up in the status bar of the App interface, click to enter.
- FIMI Navi2.0 will download and upgrade the firmware by itself.
- After the upgrade is complete, the remote control will restart automatically.

Notice:

- When upgrading, make sure that the battery level of the remote control is at least 20%.
- The entire upgrade process will take up to about 10 minutes (depending on the connection to the network and the number of firmware to be upgraded). Please ensure that the remote control can access to the Internet throughout the upgrade process.