



FIMI Manta VTOL Fixed Wing Quick Start Manual & Disclaimer

Please read the quick start manual & Disclaimer carefully before using and keep it for future reference.

Disclaimer & Warning

Thank you for purchasing this product. In order to protect your legal rights and interests, please carefully read the quick start manual, disclaimer and safety operation instructions provided with this product before using it. Fimi Technology Co. Ltd. (hereinafter referred to as “Fimi Technology”) reserves the right to update the above documents.

1. Fimi Technology shall not be held liable for all consequences caused by the purchase and maintenance of this product through unofficial channels.
2. Once you start using this product, you shall be deemed to have read, understood, approved and accepted all terms and contents of the product manual, quick start manual, disclaimer and safety operation guidelines.
3. In the process of using this product, you must strictly comply with and execute the requirements including but not limited to the instruction manual and safety instruction. Fimi Technology shall not be responsible for any adverse consequences caused by not carefully reading the instruction manual and watching the instruction video.
4. For all personal injuries, accidents, property losses, legal disputes, and other adverse events that are resulted in conflicts of interest as a result of the use of or irresistible factors in violation of safety instructions, all the relevant responsibilities and losses shall be borne by the user, and Fimi Technology shall not bear any responsibilities.
5. Fimi Technology shall not be held liable for any illegal act that occurs directly or indirectly through the use of the product by the user.
6. Any unauthorized modifications to this product, which will cause property loss and personal injury. Fimi Technology shall not assume any compensation or legal liability.
7. The propeller can cause serious injury to human body when rotating at high speed. To ensure user's safety, please turn off the drone power when operating the propeller. The user shall be liable for any legal liability arising from the omission of this clause.
8. Relevant national laws and regulations restrict the flying area of civil drone. Before using this product, the user should know about the relevant local regulations. Any legal liability arising from non-compliance with the above provisions shall be borne by the user.
9. Please do not use this product in bad weather, such as rain, snow, thunder, wind, fog, etc. Otherwise, the user shall bear the loss caused by the damage of the product.

10. Fimi Technology does not provide free maintenance service for product damage caused by user's subjective judgment or human error.
11. The user shall take full responsibility for any fire or explosion caused by improper behaviors such as man-made short circuit of the battery or use of battery at high temperature.
12. For questions not covered by this declaration, please refer to the relevant laws and regulations of the local country. If this declaration is in conflict with the relevant laws and regulations of the local country, please refer to the local laws and regulations.
13. Persons under the age of 18 and others without full capacity for civil conduct are prohibited for using this product.
14. It is prohibited to use this product in crowded places.
15. It is prohibited to use the product in areas limited by law or relevant management units.
16. Please do not use this product if you are not in good physical or mental state due to alcohol fatigue and drug effects.
17. The final interpretation right of the related statement and explanation document of this product belongs to Fimi Technology.

Safety Instructions

1. This product has high-speed rotating propellers and powerful flight power, and there are certain risks in operation. Failure to operate and use the product as required may result in danger and injury.
2. Please stay away from hazardous environment such as airport, railway, highway, high-rise building, electric wires, etc. when using this product.
3. Please stay away from the environment with high electromagnetic interference such as cell phone base station and high-power transmission equipment, etc. when using this product.
4. Please stay away from various manned craft when using this product.
5. When flying above the altitude of 3,000 meters, environmental factors will lead to the degradation of flying performance. Please use this product with caution.
6. This product is non-waterproof, please do not attempt to land on the water surface.
7. When operating this product flying at low-altitude, please always ensure that the drone keeps a safe distance of more than 10 meters from people or animals.
8. When using this product in non-sparsely populated areas, always ensure that the drone flies within the operator's visual range.
9. Please do not operate this product near the place where children are playing.
10. Please do not turn off the motor when flying in the air unless absolutely necessary.
11. The drone in abnormal working state may have accidents. Do not start the propeller or barely fly.
12. Please do not try to block any moving parts in the work of this product.
13. Please do not cover the heat dissipation part.
14. Please use original factory accessories for maintenance and replacement.
15. When lending to other operators, please first ensure that operators understand and comply with these safety instructions.
16. Please check the product before each use, including but not limited to the firmness of parts, cracks and wear of body and propeller, battery power, effectiveness of indicator lamp, etc. In case of any abnormality, please immediately stop using it and replace the corresponding accessories.

Product description

The FIMI Manta vertical takeoff and landing fixed-wing aircraft adopts a modular design, supporting quick disassembly and easy carrying. It comes with standard fixed-wing modification components and camera fixtures. Players can customize their own configurations and gameplay by using the provided foam parts for modifications. At the same time, the entire tilt mechanism uses a modular design, allowing for quick replacement and assembly. The battery compartment is compatible with 3S1P 18650, 4S1P 18650, and 3S1P 21700 batteries. The equipment compartment is compatible with DJI Skyport, O3 Skyport, and Snail Avatar Skyport. With an extra-large battery compartment and equipment compartment, it can perfectly support analog video transmission and high-definition video transmission. Some body structure blueprints are open source, allowing players to freely DIY camera mounts, camera brackets, and so on.

The fuselage is made of lightweight, high-density, environmentally friendly EPP material. The wings are reinforced with embedded carbon rods, ensuring reliable strength, durability, and easy maintenance. It features a locked four-link tilting structure, with metal gear servos and all-metal rocker arms, providing strong impact resistance and easy maintenance.

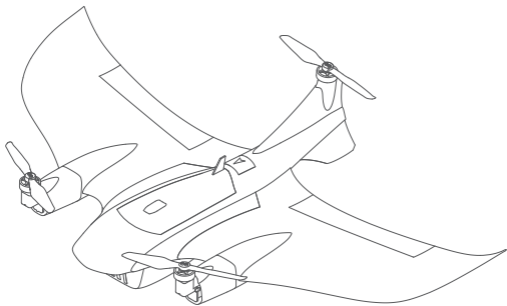

Product Assembly

1. Installation of PCB Boards at the Tilt Mechanism and Wing Sections is as shown in the following diagram:

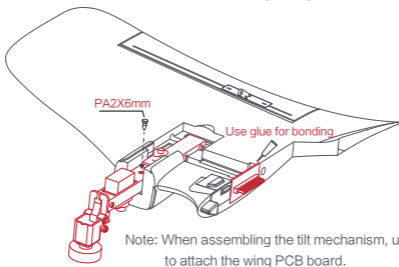

2. Installation of Wing Joining Rod is as shown in the following diagram:

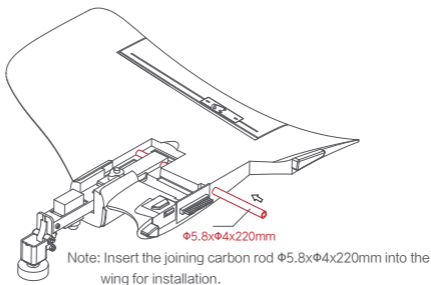

3. Installation of Wing Cover is as shown in the following diagram:

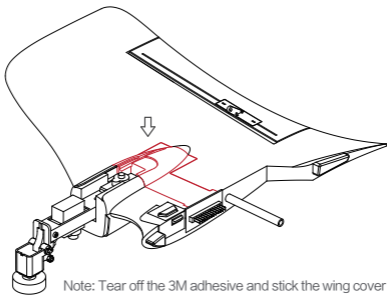

4. Installation of Wing Control Surface Pushrods is as shown in the following diagram:

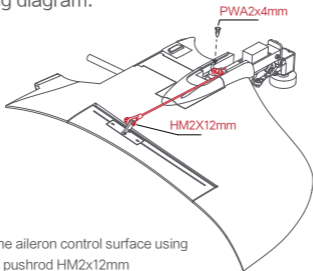

Note: Assemble the aileron control surface using the ball head pushrod HM2x12mm

5. Wing Vacuum Forming Adhesion is as shown in the following diagram:

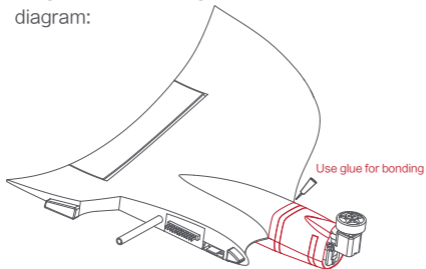

Note: Use adhesive to bond the upper and lower covers of the fairing, and use stickers to secure them tightly.

6. Wing-to-Fuselage Alignment Diagram is as shown in the following image:

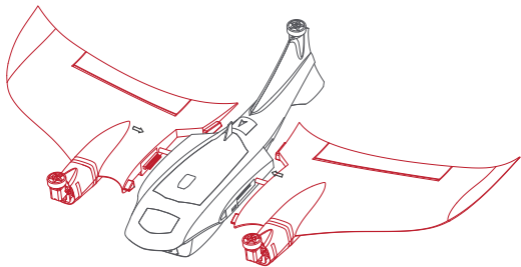

Note: Insert the wings into the fuselage on both sides to complete the assembly.

Propeller rotation direction and center of gravity position

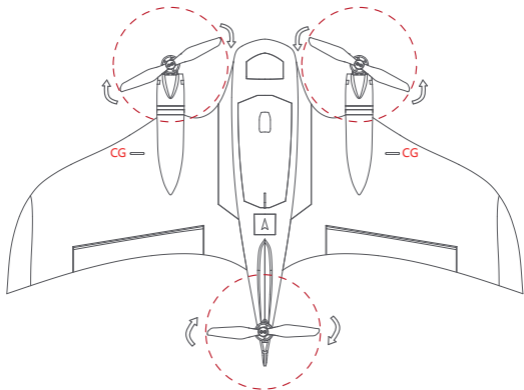

Note: As shown in the diagram, when installing the propeller blades, follow the schematic to correctly install them according to the rotation direction. Use HM2x8mm screws for installation.

Flight Controller Function Introduction

1. ArduPilot Open-Source Firmware
2. Support for GPS, HD video transmission, and CRSF protocol receivers
3. Support for electronic compass and airspeed sensor
4. Support for SBUS receivers
5. Support for analog video transmission and cameras

Flight Controller Tilt Logic Switch Configuration

Remote Controller Flight Mode Switch Channel:

1. CH6 Three-Position Switch:
 - Low Position: CRUISE
 - Middle Position: FBWA
 - High Position: QSTABILIZE
2. CH7: RTL Two-Position Switch

Configuration Introduction

PNP Configuration:

Motor: 2004-3000KV

Servos: 9g Metal Gear * 2, 9g Plastic Gear * 2

Propellers: 6026 Two-Blade Propellers

PNP-FC Configuration:

Motor: 2004-3000KV

Servos: 9g Metal Gear * 2, 9g Plastic Gear * 2

Propellers: 6026 Two-Blade Propellers

ESC (Electronic Speed Controller): 20A 3-in-1 Integrated ESC

Flight Controller: STM32-F405

GPS: M10

Note: Some parts have expansion and upgrade options, including open slots for 3D printing. These include the motor mount for the tilt mechanism, fairing sections, and installation options for the front-facing camera.